

OMRON

Stainless Steel Housing

Oil-resistant, Robust, Compact Photoelectric Sensor with Built-in Amplifier

E3ZM-C

A New Photoelectric Sensor
Designed for the Automotive and
Machine Tool Industries

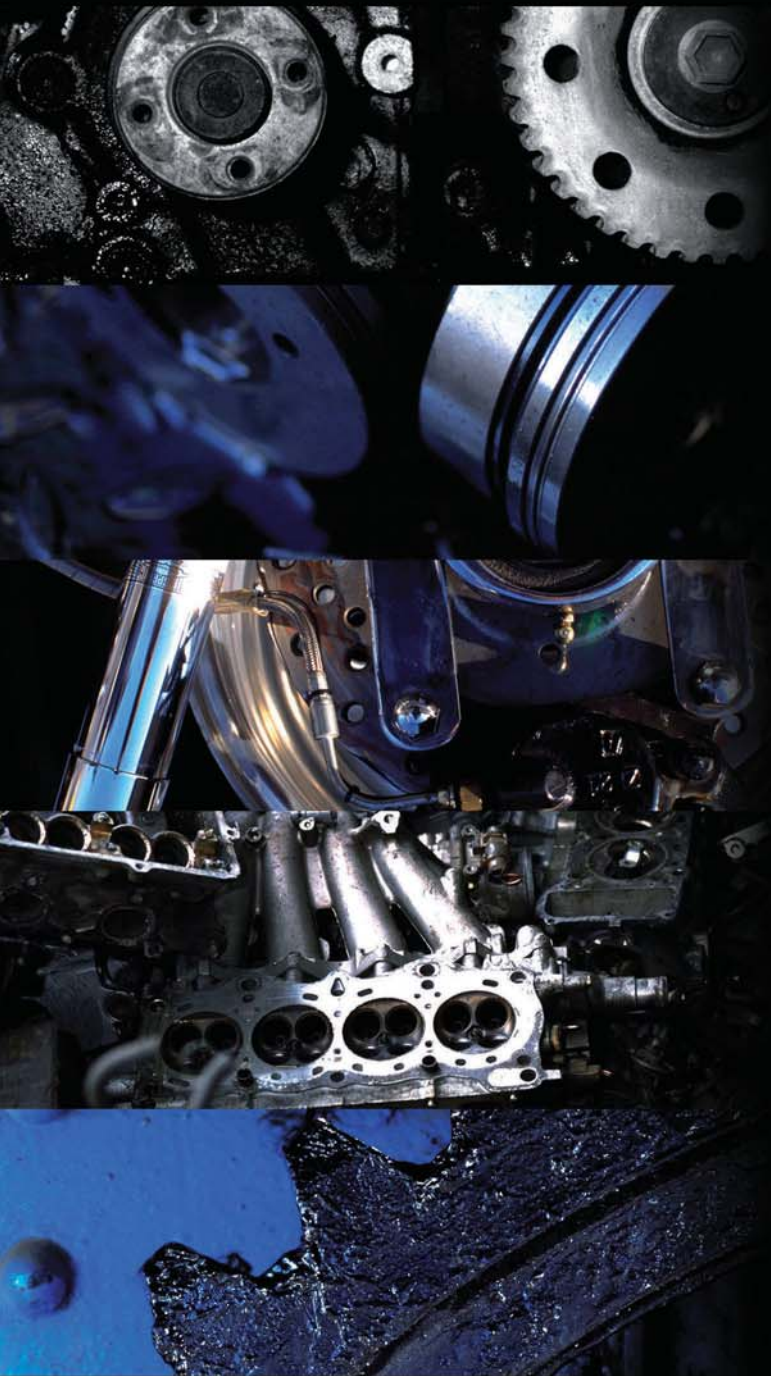
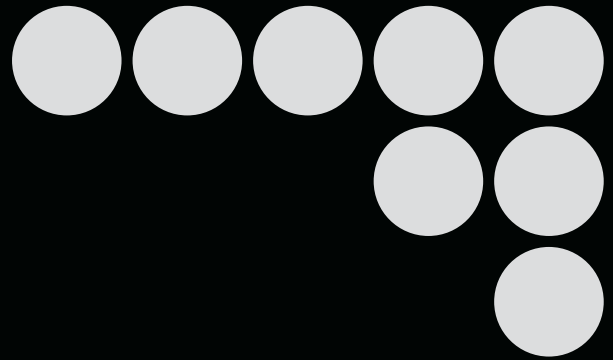

Features 1

Oil-resistant, Robust, and Compact
(IP67g Degree of Protection)

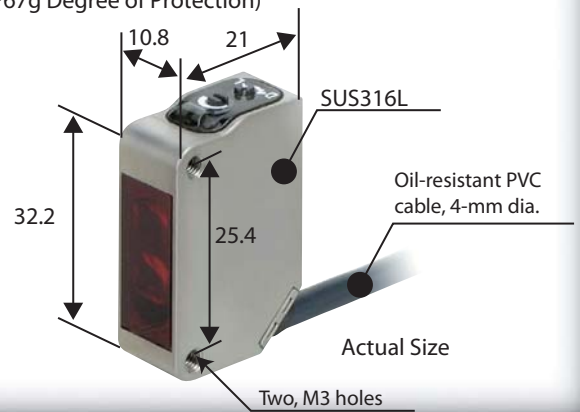

Features 2

A Through-beam Sensor with
a Visible Spot for Easy Beam
Adjustment

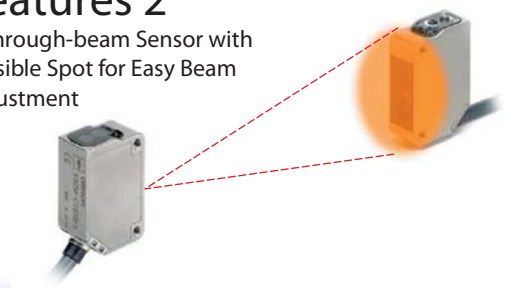

Features 3

Twist-and-Click M12 Pre-wired
Connector



Only 1/8th Turn Locks
the Connectors

realizing

A New Sensor with Stainless Steel Housing That's Strong, Compact, and Easy to Use!

Resists Oils and Coolants

The E3ZM-C features a simple shape and structure that resist oils and coolants, performance that meets or exceeds any previous models from OMRON.

The protective structure eliminates the need for screws to hold a cover, so there are no worries about loose screws leading to liquid penetration.

And the model number is laser-marked on the housing so it's always readable when the time comes to order maintenance parts.

The compact, easy-to-use E3ZM-C with built-in amplifier is ideal for oily environments.

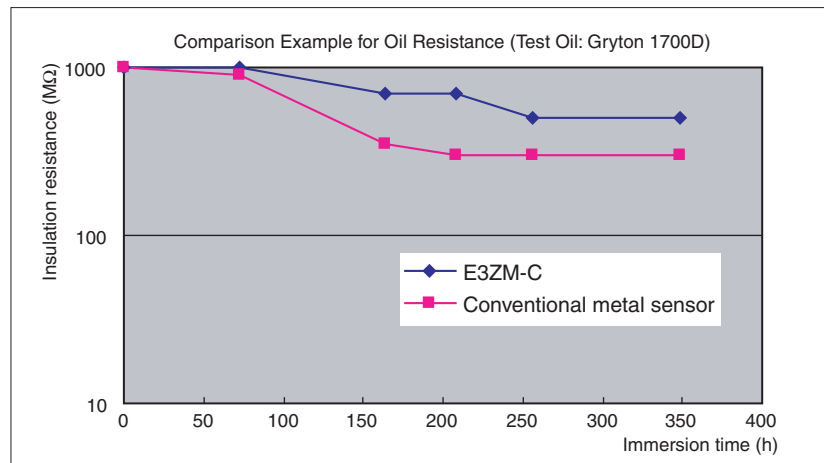

World's Smallest, and Yet Robust Patent Pending

The E3ZM-C is the same compact size as the E3Z, making it the smallest square metal photoelectric sensor in the world (according to OMRON investigation).

The SUS316L housing makes it robust, and removes all worries of the coating coming off.

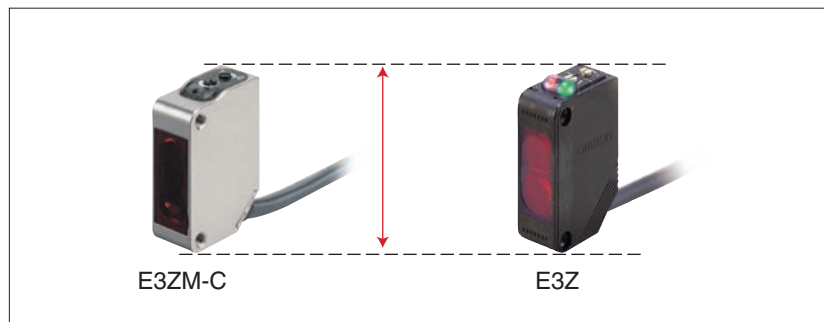

Application Precaution Use the E3ZM-T/R/D/LS in food processing or beverage filling applications where cleaners or disinfectants are present.

Advanced Industrial Automation

Perfectly Reliable Detection Performance and Connection Method

Visible Beam. Long-distance Operation Even in Dusty, Dirty Environments

The E3ZM-CT□2B uses a bright orange LED to generate a spot that's visible 1 m away. And the stronger beam used to achieve a detection distance of 20 m means that Sensor operation is possible even in dusty, dirty environments (response time: 2 ms). It all adds up to a more visible, more dependable worksite.

E3ZM-CT□2B
Bright Orange Spot

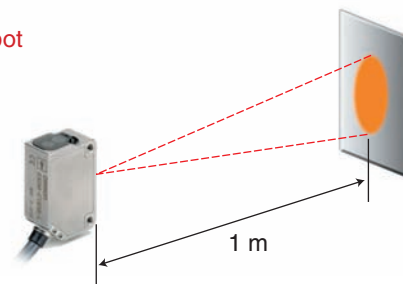

Simple, Yet Dependable M12 Twist-and-Click Pre-wired Connectors

These Connectors match the XS5 Connectors, which reduce wiring work. They eliminate the troublesome need to control torque when tightening connectors, and remove worries about screws loosening due to vibration.

E3ZM-C□□□-M1TJ
Locks with a 1/8th Turn

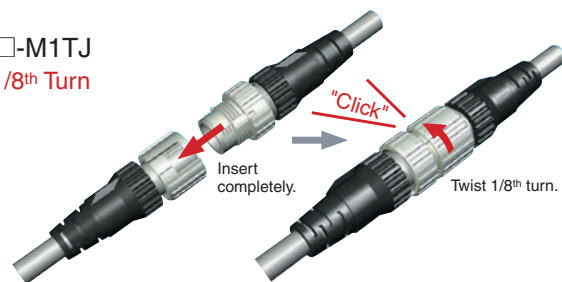

Unique Miniaturization and Modularization Technologies

Sensing Module

The optical system and signal processing are all contained in one module, providing all the main functions required of a Photoelectric Sensor.

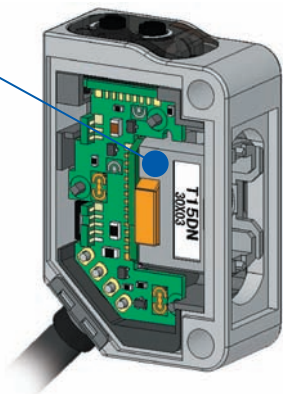

Internal Structure

Optical System

Maximizes manufacturing technology, including sophisticated inline optical axis adjustment.

Signal Processing

Leading-edge technology for stabilization and miniaturization is obvious in the photo IC, which includes an external light interference prevention algorithm, CSP* mounting, and other components.

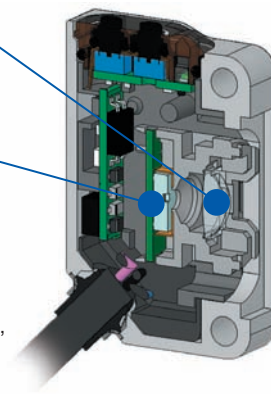

Cross Section

*Chip Scale Package

Oil-resistant, Robust, Compact Photoelectric Sensor (Stainless Housing and Built-in Amplifier)

E3ZM-C

Designed for the Automotive and Machine Tool Industries

- Oil-resistant, water-resistant, robust body made of stainless steel.
- Same size as the E3Z: The smallest square metal photoelectric sensor in the world.
- Through-beam Models with an orange spot that's visible 1 m away, and a long distance detection to reduce the influence of dirt (detection distance: 20 m, response time: 2 ms).
- Models with M12 twist-and-click pre-wired connectors.
- Reversed output polarity protection, external light interference prevention algorithm, and RoHS compliance to inherit the E3Z's reliability.











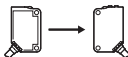
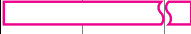

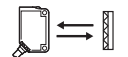
 Refer to "Safety Precautions" on page 13

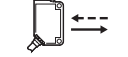
Ordering Information

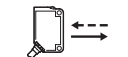
Sensors

 Orange light  Red light  Infrared light



Sensing method	Appearance	Connection method	Sensing distance	Model		
				NPN output	PNP output	
Through-beam		Pre-wired (2 m)		15 m	E3ZM-CT61	E3ZM-CT81
		Pre-wired (5 m)			E3ZM-CT61 5M	E3ZM-CT81 5M
		M12 twist-and-click pre-wired connector (0.3 m)			E3ZM-CT61-M1TJ	E3ZM-CT81-M1TJ
		Connector (M8, 4 pins)			E3ZM-CT66	E3ZM-CT86
		Pre-wired (2 m)		20 m	E3ZM-CT62B	E3ZM-CT82B
		Pre-wired (5 m)			E3ZM-CT62B 5M	E3ZM-CT82B 5M
		M12 twist-and-click pre-wired connector (0.3 m)			E3ZM-CT62B-M1TJ	E3ZM-CT82B-M1TJ
		Connector (M8, 4 pins)			E3ZM-CT67B	E3ZM-CT87B
Retro-reflective		Pre-wired (2 m)		4 m (100 mm)	E3ZM-CR61	E3ZM-CR81
		M12 twist-and-click pre-wired connector (0.3 m)			E3ZM-CR61-M1TJ	E3ZM-CR81-M1TJ
		Connector (M8, 4 pins)			E3ZM-CR66	E3ZM-CR86
Diffuse-reflective		Pre-wired (2 m)		1 m	E3ZM-CD62	E3ZM-CD82
		M12 twist-and-click pre-wired connector (0.3 m)			E3ZM-CD62-M1TJ	E3ZM-CD82-M1TJ
		Connector (M8, 4 pins)			E3ZM-CD67	E3ZM-CD87
BGS reflective		Pre-wired (2 m)		10 to 100 mm	E3ZM-CL61H	E3ZM-CL81H
		M12 twist-and-click pre-wired connector (0.3 m)			E3ZM-CL61H-M1TJ	E3ZM-CL81H-M1TJ
		Connector (M8, 4 pins)			E3ZM-CL66H	E3ZM-CL86H
		Pre-wired (2 m)		10 to 150 mm	E3ZM-CL62H	E3ZM-CL82H
		M12 twist-and-click pre-wired connector (0.3 m)			E3ZM-CL62H-M1TJ	E3ZM-CL82H-M1TJ
		Connector (M8, 4 pins)			E3ZM-CL67H	E3ZM-CL87H
		Pre-wired (2 m)		10 to 200 mm	E3ZM-CL64H	E3ZM-CL84H
		M12 twist-and-click pre-wired connector (0.3 m)			E3ZM-CL64H-M1TJ	E3ZM-CL84H-M1TJ
		Connector (M8, 4 pins)			E3ZM-CL69H	E3ZM-CL89H

Let Us Know What You Need

1. Retro-reflective, Diffuse-reflective, and BGS-reflective Models are also available with a 5-m pre-wired cable. When ordering, add the cable length to the end of the model number (e.g., E3ZM-CD62 5M).
 2. Models with no moving parts (i.e., without a sensitivity adjuster or mode selection switch) are also available, as are models with built-in slits (through-beam, 0.8 m) (e.g., E3ZM-CT83H 2M for no sensitivity adjustment, wire-connection selection of operating mode, and built-in slit).
 3. Except for the E3ZM-CL□□H, models with 3-pin M8 connectors are available. When ordering, add “-M5” to the end of the model number (e.g., E3ZM-CT66-M5).
 4. Through-beam Models are also available with a light emission stop function. When ordering, add “-G0” to the end of the model number (e.g., E3ZM-T61-G0).
- Ask your OMRON representative for details on any models or specifications you require.









Accessories

Sensor I/O Connectors

Size	Cable	Appearance	Cable type	Model	
M12 (For -M1TJ models)	Standard	Straight 	2 m	4-wire	XS5F-D421-D80-A
			5 m		XS5F-D421-G80-A
M8 (4 pins)	Standard	Straight 	2 m	4-wire	XS3F-M421-402-A
			5 m		XS3F-M421-405-A
		L-shaped 	2 m		XS3F-M422-402-A
			5m		XS3F-M422-405-A

Note: Ask your OMRON representative about connectors with other specifications.

Mounting Brackets

Appearance	Model (Material)	Quantity	Remarks	Appearance	Model (Material)	Quantity	Remarks
	E39-L153 (SUS304)	1	Mounting Brackets		E39-L98 (SUS304)	1	Metal Protective Cover Bracket *
	E39-L104 (SUS304)	1			E39-L150 (SUS304)	1 set	(Sensor adjuster)
	E39-L43 (SUS304)	1	Horizontal Mounting Bracket *		E39-L151 (SUS304)	1 set	Easily mounted to the aluminum frame rails of conveyors and easily adjusted.
	E39-L142 (SUS304)	1	Horizontal Protective Cover Bracket *				For vertical angle adjustment
	E39-L44 (SUS304)	1	Rear Mounting Bracket		E39-L144 (SUS304)	1	Compact Protective Cover Bracket *

Note: When using Through-beam Models, order one bracket for the Receiver and one for the Emitter.

* Cannot be used for Standard Connector models.

Reflector

Name	E3ZM-CR Sensing distance (typical) *	Model	Quantity	Remarks
Reflector	3 m (100 mm) (rated value)	E39-R1	1	<ul style="list-style-type: none"> • Reflectors are not provided with Retro-reflective models. • The MSR function is enabled.
	4 m (100 mm) (rated value)	E39-R1S	1	
	5 m (100 mm)	E39-R2	1	
	2.5 m (100 mm)	E39-R9	1	
	3.5 m (100 mm)	E39-R10	1	
Small Reflector	1.5 m (50 mm)	E39-R3	1	

Note: When using a Reflector without a rated value, use 0.7 times typical value as a guideline for the sensing distance.

* Values in parentheses indicate the minimum required distance between the Sensor and Reflector.

Ratings and Specifications

Model	Sensing method	Through-beam		Retro-reflective with MSR function	Diffuse-reflective
		NPN output	E3ZM-CT61 (-M1TJ) E3ZM-CT66	E3ZM-CT62B (-M1TJ) E3ZM-CT67B	E3ZM-CR61 (-M1TJ) E3ZM-CR66
Item	PNP output	E3ZM-CT81 (-M1TJ) E3ZM-CT86	E3ZM-CT82B (-M1TJ) E3ZM-CT87B	E3ZM-CR81 (-M1TJ) E3ZM-CR86	E3ZM-CD82 (-M1TJ) E3ZM-CD87
Sensing distance		15 m	20 m	4 m [100 mm] (Using E39-R1S) 3 m [100 mm] (Using E39-R1)	1 m (White paper 300 × 300 mm)
Spot diameter		---			
Standard sensing object		Opaque: 12-mm dia. min.		Opaque: 75-mm dia. min.	---
Differential travel		---			20% of sensing distance max.
Black/white error		---			
Directional angle		Emitter, Receiver: 3° to 15° (Distance between emitter and receiver. Rated sensing distance)		Sensor: 3° to 10° Reflector: 30° (Distance to Reflector. Rated sensing distance)	---
Light source (wavelength)		Infrared LED (870 nm)	Orange LED (615 nm)	Red LED (660 nm)	Infrared LED (860 nm)
Power supply voltage		10 to 30 VDC, including 10% ripple (p-p)			
Current consumption		40 mA (Emitter 20 mA max., Receiver 20 mA max.)		25 mA max.	
Control output		Load power supply voltage: 30 VDC max., Load current: 100 mA max. (Residual voltage: 2 V max.) Open-collector output (NPN/PNP output depending on model) Light-ON/Dark-ON switch selectable			
Protection circuits		Reversed power supply polarity protection, Output short-circuit protection, and Reversed output polarity protection		Reversed power supply polarity protection, Output short-circuit protection, Reversed output polarity protection, and Mutual interference prevention	
Response time		Operate or reset: 1 ms max.	Operate or reset: 2 ms max.	Operate or reset: 1 ms max.	
Sensitivity adjustment		One-turn adjuster			
Ambient illumination (Receiver side)		Incandescent lamp: 3,000 lx max., Sunlight: 10,000 lx max.			
Ambient temperature range		Operating: -25 to 55°C, Storage: -40 to 70°C (with no icing or condensation)			
Ambient humidity range		Operating: 35% to 85%, Storage: 35% to 95% (with no condensation)			
Insulation resistance		20 MΩ min. at 500 VDC			
Dielectric strength		1,000 VAC, 50/60 Hz for 1 min			
Vibration resistance		Destruction: 10 to 55 Hz, 1.5-mm double amplitude for 2 hours each in X, Y, and Z directions			
Shock resistance		Destruction: 500 m/s ² 3 times each in X, Y, and Z directions			
Degree of protection *		IEC: IP67, DIN 40050-9: IP69K			
Connection method		-C□□1/-C□□2(B): Pre-wired cable (standard length: 2 m, -M1TJ: Pre-wired connector with 0.3-m cable) -C□□6/-C□□7(B): M8 4-pin connector			
Indicator		Operation indicator (yellow), Stability indicator (green) (Emitter has only power supply indicator (green).)			
Weight (packed state)	Pre-wired models	Approx. 150 g (-M1TJ: Approx. 90 g)		Approx. 90 g (-M1TJ: Approx. 50 g)	
	Connector models	Approx. 60 g		Approx. 40 g	
Materials	Housing	SUS316L			
	Lens	PMMA (polymethylmethacrylate)			
	Indication	PES (polyethersulfone)			
	Sensitivity adjustment and mode selector switch	PEEK (polyetheretherketone)			
	Seals	Fluoro rubber			
Accessories		Instruction sheet (Note: Reflectors and Mounting Brackets are sold separately.)			

* IP69K Degree of Protection Specification
 IP69K is a protection standard against high temperature and high-pressure water defined in the German standard DIN 40050, Part 9. The test piece is sprayed with water at 80°C at a water pressure of 80 to 100 BAR using a specified nozzle shape at a rate of 14 to 16 liters/min.
 The distance between the test piece and nozzle is 10 to 15 cm, and water is sprayed horizontally for 30 seconds each at 0°, 30°, 60°, and 90° while rotating the test piece on a horizontal plane.

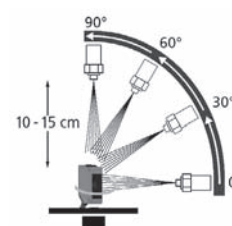

		BGS Reflective		
Model	Sensing method			
	NPN output	E3ZM-CL61H (-M1TJ) E3ZM-CL66H	E3ZM-CL62H (-M1TJ) E3ZM-CL67H	E3ZM-CL64H (-M1TJ) E3ZM-CL69H
Item	PNP output	E3ZM-CL81H (-M1TJ) E3ZM-CL86H	E3ZM-CL82H (-M1TJ) E3ZM-CL87H	E3ZM-CL84H (-M1TJ) E3ZM-CL89H
Sensing distance		10 to 100 mm (White paper 100 × 100 mm)	10 to 150 mm (White paper 100 × 100 mm)	10 to 200 mm (White paper 100 × 100 mm)
Spot diameter		4-mm dia. at sensing distance of 100 mm	12-mm dia. at sensing distance of 150 mm	18-mm dia. at sensing distance of 200 mm
Standard sensing object		---		
Differential travel		3% of sensing distance max.	15% of sensing distance max.	20% of sensing distance max.
Black/white error		5% of sensing distance max.	10% of sensing distance max.	20% of sensing distance max.
Directional angle		---		
Light source (wavelength)		Red LED (650 nm)	Red LED (660 nm)	
Power supply voltage		10 to 30 VDC, including 10% ripple (p-p)		
Current consumption		25 mA max.		
Control output		Load power supply voltage: 30 VDC max., Load current: 100 mA max. (Residual voltage: 2 V max.) Open-collector output (NPN/PNP output depending on model) Light-ON/Dark-ON cable connection selectable		
Protection circuits		Reversed power supply polarity protection, Output short-circuit protection, Reversed output polarity protection, Mutual interference protection		
Response time		Operate or reset: 1 ms max.		
Sensitivity adjustment		---		
Ambient illumination (Receiver side)		Incandescent lamp: 3,000 lx max., Sunlight: 10,000 lx max.		
Ambient temperature range		Operating: -25 to 55°C, Storage: -40 to 70°C (with no icing or condensation)		
Ambient humidity range		Operating: 35% to 85%, Storage: 35% to 95% (with no condensation)		
Insulation resistance		20 MΩ min. at 500 VDC		
Dielectric strength		1,000 VAC, 50/60 Hz for 1 min		
Vibration resistance		Destruction: 10 to 55 Hz, 1.5-mm double amplitude for 2 hours each in X, Y, and Z directions		
Shock resistance		Destruction: 500 m/s ² 3 times each in X, Y, and Z directions		
Degree of protection *		IEC: IP67, DIN 40050-9: IP69K		
Connection method		-CL□□1H/-CL□□2H/-CL□□4H: Pre-wired cable (standard length: 2 m, -M1TJ: Pre-wired connector with 0.3-m cable) -CL□□6H/-CL□□7H/-CL□□9H: M8 4-pin connector		
Indicator		Operation indicator (yellow), Stability indicator (green)		
Weight (packed state)	Pre-wired models	Approx. 90 g (-M1TJ: Approx. 50 g)		
	Connector models	Approx. 40 g		
Materials	Housing	SUS316L		
	Cable	Oil-resistant vinyl cable		
	Lens	PMMA (polymethylmethacrylate)		
	Display	PES (polyethersulfone)		
	Seals	Fluoro rubber		
Accessories		Instruction sheet (Note: Mounting Brackets are sold separately.)		

Engineering Data (Typical)

Parallel Operating Range Through-beam Models E3ZM-CT□1/-CT□6

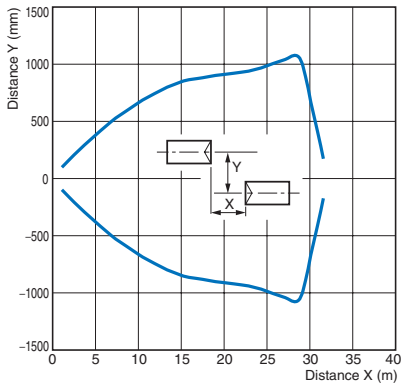

E3ZM-CT□2B/-CT□7B

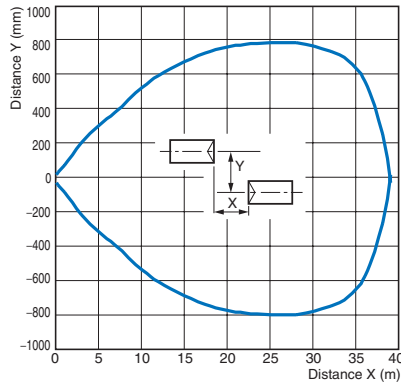

Retro-reflective Models E3ZM-CR□1/-CR□6

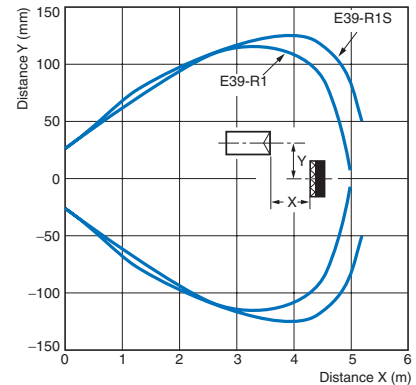

Operating Range Diffuse-reflective Models E3ZM-CD□2/-CD□6

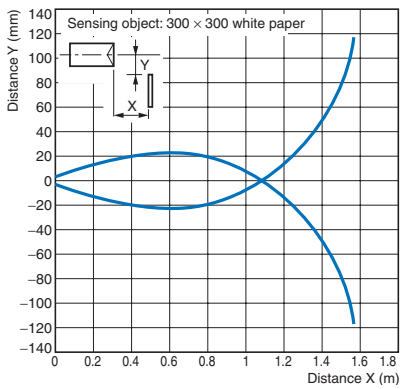

BGS Reflective Models E3ZM-CL□1H/-CL□6H (Vertical)

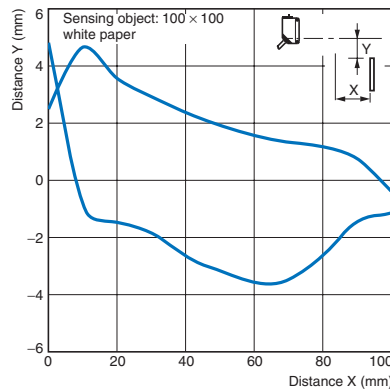

E3ZM-CL□1H/-CL□6H (Horizontal)

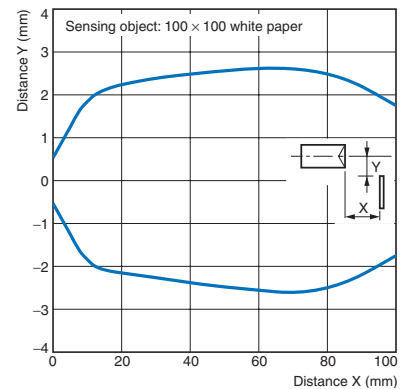

E3ZM-CL□2H/-CL□7H (Vertical)

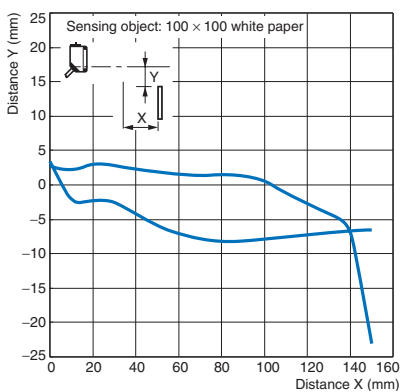

E3ZM-CL□H/-CL□7H (Horizontal)

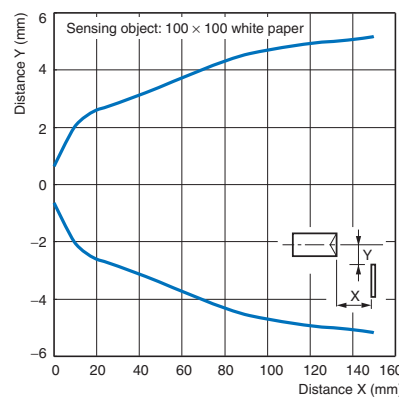

E3ZM-CL□4H/-CL□9H (Vertical)

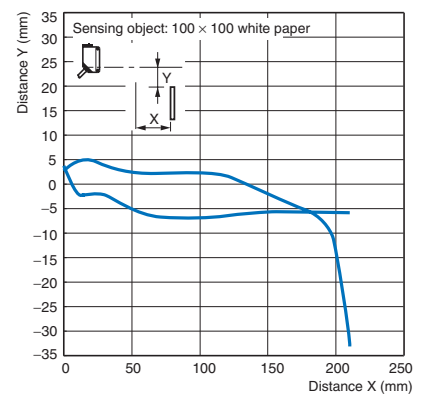

E3ZM-CL□4H/-CL□9H (Horizontal)

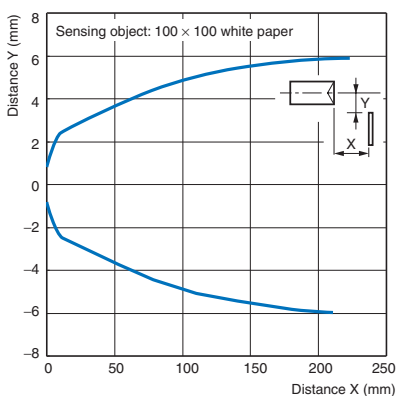

Excess Gain vs. Distance

Through-beam Models

E3ZM-CT□1/-CT□6

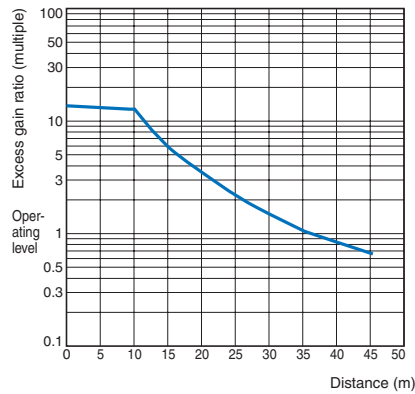

E3ZM-CT□2B/-CT□7B

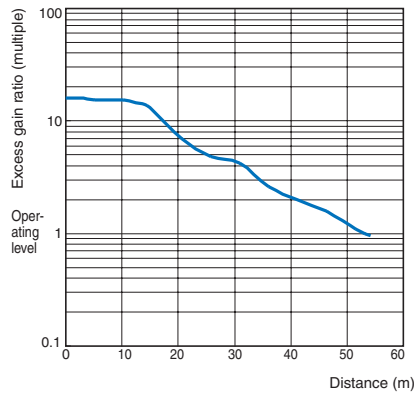

Retro-reflective Models

E3ZM-CR□1/-CR□6

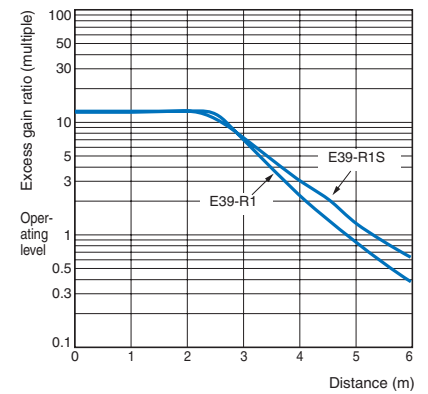

Diffuse-reflective Models

E3ZM-CD□2/-CR□7

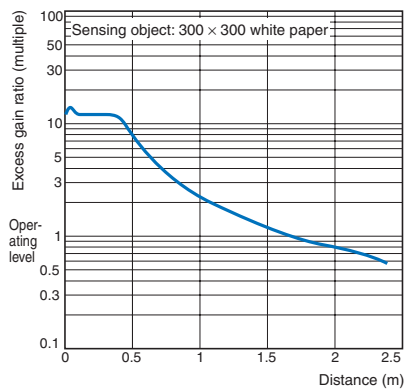

Sensing Object Size vs. Distance

Diffuse-reflective Models

E3ZM-CD□2/-CD□7

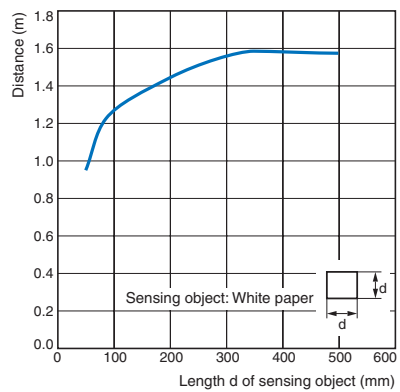

Spot Diameter vs. Distance

BGS Reflective Models

E3ZM-CL□1H/-CL□6H

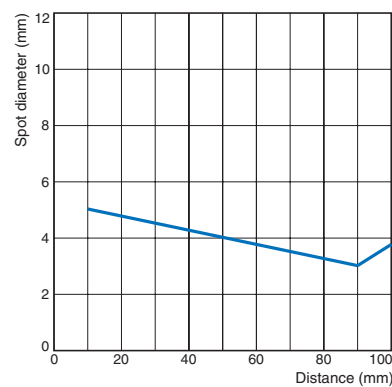

E3ZM-CL□2H/-CL□4H/-CL□7H/-CL□9H

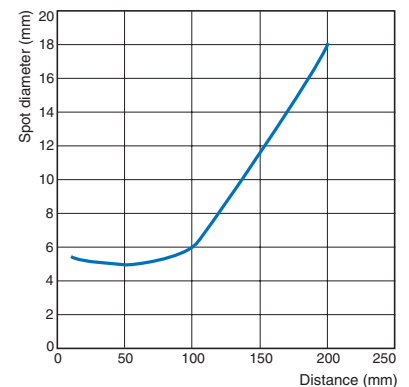

Sensing Distance vs. Sensing Object Material

BGS Reflective Models

E3ZM-CL□1H/-CL□6H

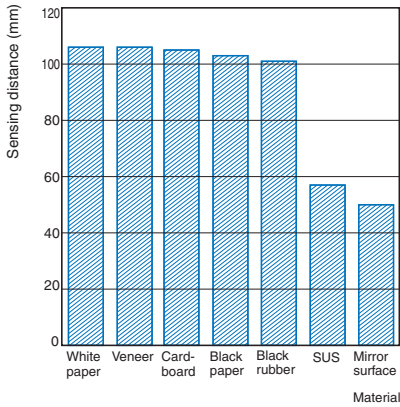

E3ZM-CL□2H/-CL□7H

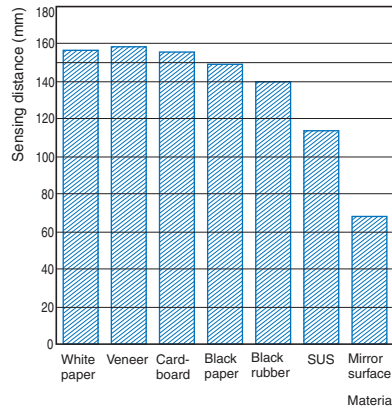

E3ZM-CL□4H/-CL□9H

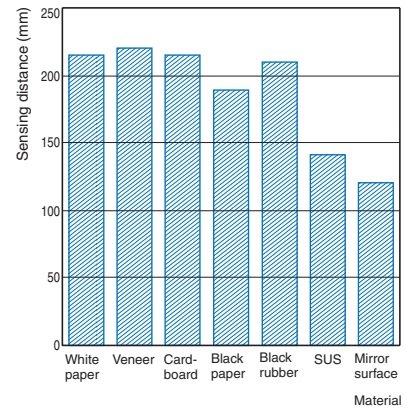

Inclination Characteristics

BGS Reflective Models

E3ZM-CL□1H (CL□6H) (Vertical)

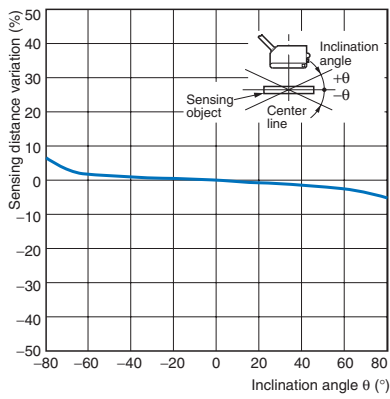

E3ZM-CL□2H (CL□7H) (Vertical)

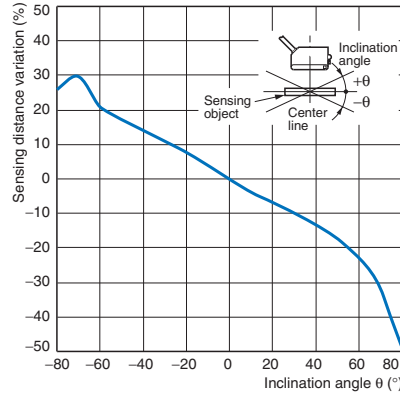

E3ZM-CL□4H (CL□9H) (Vertical)

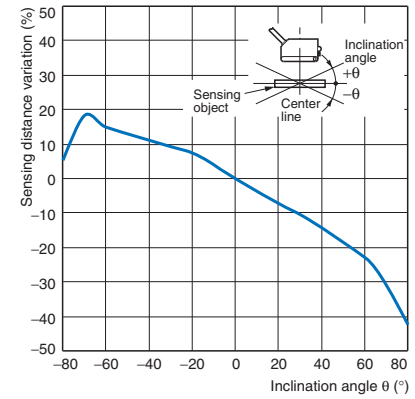

Inclination Characteristics

BGS Reflective Models

E3ZM-CL□1H (CL□6H) (Horizontal)

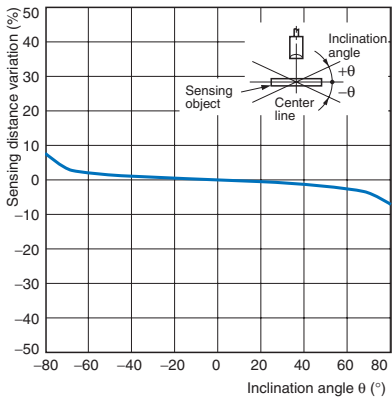

E3ZM-CL□2H (CL□7H) (Horizontal)

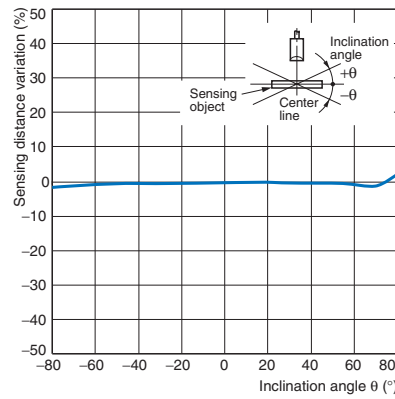

E3ZM-CL□4H (CL□9H) (Horizontal)

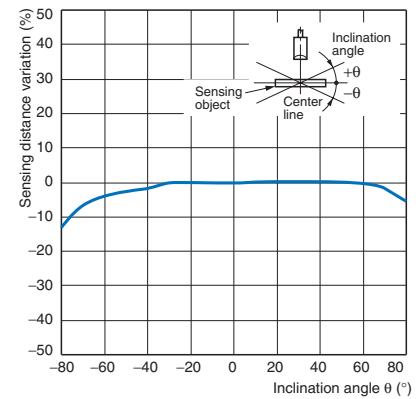

I/O Circuit Diagrams

NPN Output

Model	Operation mode	Timing charts	Operation selector	Output circuit
E3ZM-CT61 E3ZM-CT66 E3ZM-CT62B E3ZM-CT67B E3ZM-CR61 E3ZM-CD66 E3ZM-CD62 E3ZM-CD67	Light-ON		L side (LIGHT ON)	<p>Through-beam Receivers, Retro-reflective Models, Diffuse-reflective Models</p>
	Dark-ON		D side (DARK ON)	
E3ZM-CL61H E3ZM-CL66H E3ZM-CL62H E3ZM-CL67H E3ZM-CL64H E3ZM-CL69H	Light-ON		Connect pink lead (2) to brown lead (1).	
	Dark-ON		Connect pink lead (2) to blue lead (3) or leave open.	

PNP Output

Model	Operation mode	Timing charts	Operation selector	Output circuit
E3ZM-CT81 E3ZM-CT86 E3ZM-CT82B E3ZM-CT87B E3ZM-CR81 E3ZM-CD86 E3ZM-CD82 E3ZM-CD87	Light-ON		L side (LIGHT ON)	<p>Through-beam Receivers, Retro-reflective Models, Diffuse-reflective Models</p>
	Dark-ON		D side (DARK ON)	
E3ZM-CL81H E3ZM-CL86H E3ZM-CL82H E3ZM-CL87H E3ZM-CL84H E3ZM-CL89H	Light-ON		Connect pink lead (2) to brown lead (1).	
	Dark-ON		Connect pink lead (2) to blue lead (3) or leave open.	

Emitter (Either NPN or PNP Output)

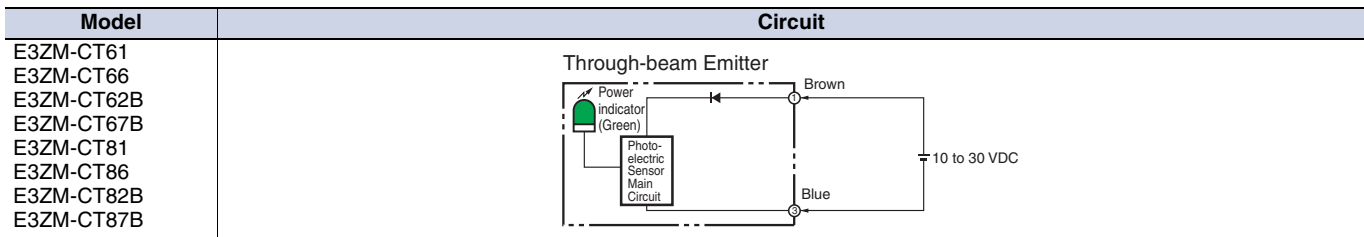

Connector Pin Arrangement

M12 Pre-wired Connector

M12 Connector Pin Arrangement



Plugs (Sensor I/O Connectors)

M12 Connector

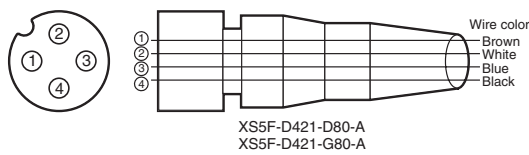

M8 Connector

M8 4-pin Connector Pin Arrangement



M8 3-pin Connector Pin Arrangement



M8 4-pin Connectors

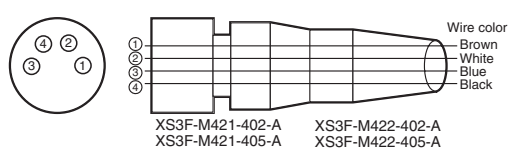

Classification	Wire color	Connector pin No.	Application
DC	Brown	1	Power supply (+V)
	White	2	Operation selection/ stopping light emission (-G0 only)
	Blue	3	Power supply (0 V)
	Black	4	Output

Note: The above M8 and M12 Connectors made by OMRON are IP67. Do not use them in an environment where IP69K is required.

Nomenclature

Sensors with Sensitivity Adjustment and Operation Selector

Through-beam Models
E3ZM-CT□□ (Receiver)

Retro-reflective Models
E3ZM-CR□□

Diffuse-reflective Models
E3ZM-CD□□

Infinite Adjustment Emitter

BGS Reflective Models
E3ZM-CL□□H

Through-beam Models
E3ZM-CT□□ (Emitter)

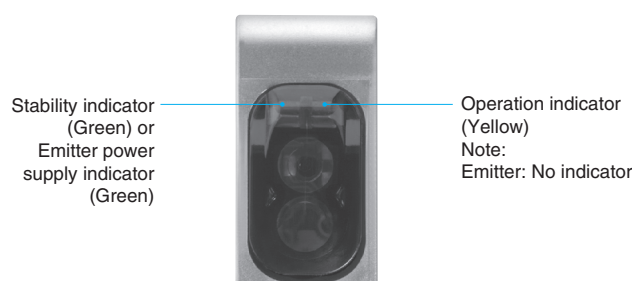
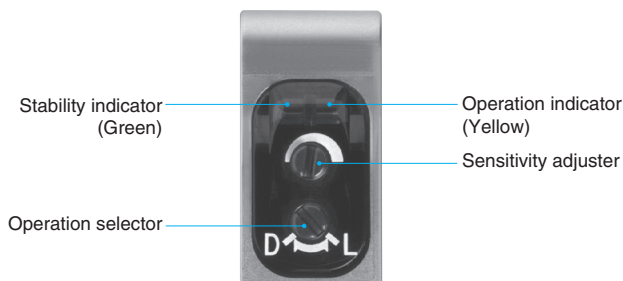

Safety Precautions

Refer to *Warranty and Limitations of Liability* on page 20.

WARNING

This product is not designed or rated for directly or indirectly ensuring safety of persons. Do not use it for such a purpose.



CAUTION

Do not use the product with voltage in excess of the rated voltage. Excess voltage may result in malfunction or fire.



Never use the product with an AC power supply. Otherwise, explosion may result.



When cleaning the product, do not apply a high-pressure spray of water to one part of the product. Otherwise, parts may become damaged and the degree of protection may be degraded.



High-temperature environments may result in burn injury.



Precautions for Safe Use

The following precautions must be observed to ensure safe operation of the Sensor.

Operating Environment

Do not use the Sensor in an environment where explosive or flammable gas is present.

Connecting Connectors

Be sure to hold the connector cover when inserting or removing the connector. Be sure to tighten the connector lock by hand; do not use pliers or other tools. If the tightening is insufficient, the degree of protection will not be maintained and the Sensor may become loose due to vibration. The appropriate tightening torque is 0.39 to 0.49 N·m for M12 metal connectors and 0.3 to 0.4 N·m for M8 metal connectors.

Load

Do not use a load that exceeds the rated load.

Low-temperature Environments

Do not touch the metal surface with your bare hands when the temperature is low. Touching the surface may result in a cold burn.

Rotation Torque for Sensitivity Adjustment and Selector Switch

Adjust with a torque of 0.06 N·m or less.

Environments with Cleaners and Disinfectants (e.g., Food Processing Lines)

Do not use the Sensor in environments subject to cleaners and disinfectants. They may reduce the degree of protection.

Modifications

Do not attempt to disassemble, repair, or modify the Sensor.

Outdoor Use

Do not use the Sensor in locations subject to direct sunlight.

Cleaning

Do not use thinner, alcohol, or other organic solvents. Otherwise, the

optical properties and degree of protection may be degraded.

Surface Temperature

Burn injury may occur. The Sensor surface temperature rises depending on application conditions, such as the ambient temperature and the power supply voltage. Use caution when operating or performing maintenance on the Sensor.

Precautions for Correct Use

Do not use the Sensor in any atmosphere or environment that exceeds the ratings.

Do not install the Sensor in the following locations.

- (1) Locations subject to direct sunlight
- (2) Locations subject to condensation due to high humidity
- (3) Locations subject to corrosive gas
- (4) Locations where the Sensor may receive direct vibration or shock

Connecting and Mounting

- (1) The maximum power supply voltage is 30 VDC. Before turning the power ON, make sure that the power supply voltage does not exceed the maximum voltage.
- (2) Laying Sensor wiring in the same conduit or duct as high-voltage wires or power lines may result in malfunction or damage due to induction. As a general rule, wire the Sensor in a separate conduit or use shielded cable.
- (3) Use an extension cable with a minimum thickness of 0.3 mm² and less than 100 m long.
- (4) Do not pull on the cable with excessive force.
- (5) Pounding the Photoelectric Sensor with a hammer or other tool during mounting will impair water resistance. Also, use M3 screws.
- (6) Mount the Sensor either using the bracket (sold separately) or on a flat surface.
- (7) Be sure to turn OFF the power supply before inserting or removing the connector.

Cleaning

Never use thinner or other solvents. Otherwise, the Sensor surface may be dissolved.

Power Supply

If a commercial switching regulator is used, ground the FG (frame ground) terminal.

Power Supply Reset Time

The Sensor will be able to detect objects 100 ms after the power supply is turned ON. Start using the Sensor 100 ms or more after turning ON the power supply. If the load and the Sensor are connected to separate power supplies, be sure to turn ON the Sensor first.

Turning OFF the Power Supply

Output pulses may be generated even when the power supply is OFF. Therefore, it is recommended to first turn OFF the power supply for the load or the load line.

Load Short-circuit Protection

This Sensor is equipped with load short-circuit protection, but be sure to not short circuit the load. Be sure to not use an output current flow that exceeds the rated current. If a load short circuit occurs, the output will turn OFF, so check the wiring before turning ON the power supply again. The short-circuit protection circuit will be reset. The load short-circuit protection will operate when the current flow reaches 1.8 times the rated load current. When using a capacitive load, use an inrush current of 1.8 times the rated load current or lower.

Water Resistance

Do not use the Sensor in water, rainfall, or outdoors.

When disposing of the Sensor, treat it as industrial waste.

Mounting Diagram

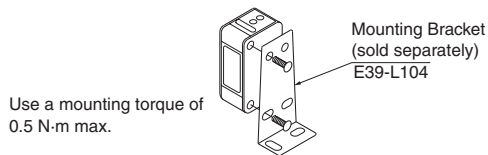

Oil Resistance

- The Sensor has passed oil resistance testing for the oils listed in the following table. Use this table as a guide when considering lubricants and cutting oils.

Test oil type	Product name	Kinetic viscosity at 40°C (mm ² /s)	pH (dilution rate)
Lubricants	Velocity Oil No. 3	2.02	---
Non-water-soluble cutting oils	Yushiron Oil No.2 AC	Less than 10	---
Water-soluble cutting oils	Yushiroken EC50T3	---	10.1 (×30)
	Yushiroken EC50T5		9.9 (×30)
	Yushiroken S46D		9.9 (×50)
	Yushiroken S50N		8.6 (×50)
	Yushiron Lubic HWC68		9.1 (×30)
	Yushiroken Synthetic #770TG		9.9 (×20)
	Emulcut FA-900ST		9.7 (×30)
	Multicool CSF-9000		9.7 (×20)
	Sugicut CS-68JS-1		9.6 (×20)
	Toyocool 3A-666		9.6 (×20)
	Gryton 1700		9.1 (×10)
Gryton 1700D	9.3 (×3)		

- Note:**
1. The Sensor was immersed in the above oils for 240 h at 55°C and then passed an insulation resistance test at 100 MΩ.
 2. Use the kinetic viscosities and pHs in the above table as a guide when using the Sensor in environments containing oils not listed in the table. Additives in the oil may also affect performance. Always test applicability in advance.

Dimensions

Sensors

Through-beam Models

Pre-wired Models

- E3ZM-CT61
- E3ZM-CT81
- E3ZM-CT62B
- E3ZM-CT82B



Emitter

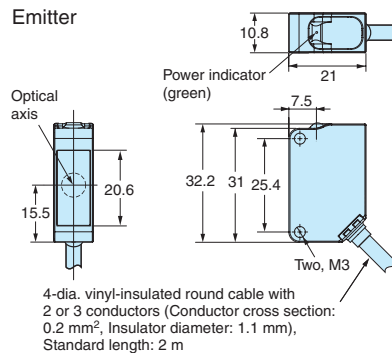

M12 Pre-wired Connector (E3ZM-□□□-M1TJ)

*4-dia. vinyl-insulated round cable with 3 conductors. Standard length: 0.3 m

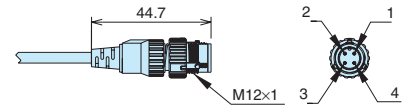

Terminal No.	Specifications
1	+V
2	Light emission stop input (-G0 only)
3	0 V
4	---

Receiver

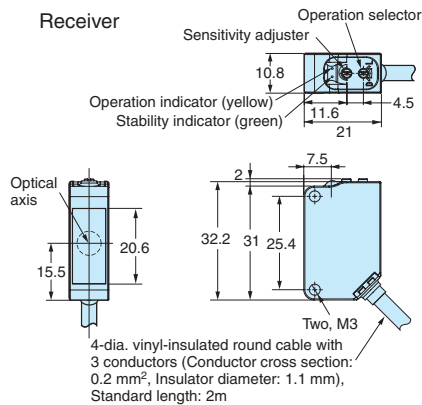

M12 Pre-wired Connector (E3ZM-□□□-M1TJ)

*4-dia. vinyl-insulated round cable with 3 conductors. Standard length: 0.3 m

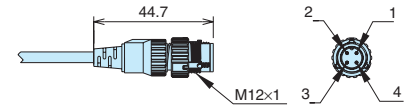

Terminal No.	Specifications
1	+V
2	---
3	0 V
4	Output

Through-beam Models

Connector Models

- E3ZM-CT66
- E3ZM-CT86
- E3ZM-CT67B
- E3ZM-CT87B



Emitter

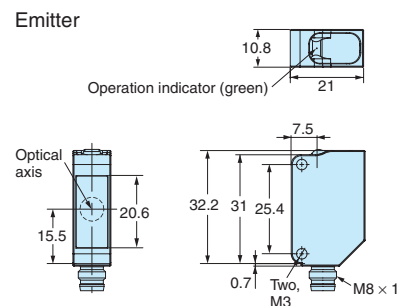

Terminal No.	Specifications
1	+V
2	Light emission stop input (-G0 only)
3	0 V
4	---

Receiver

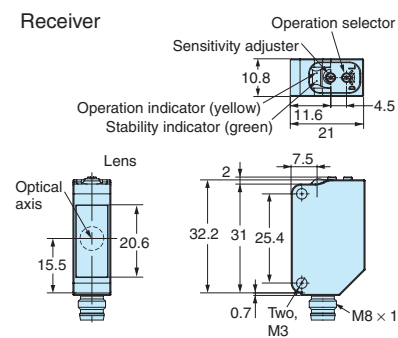

Terminal No.	Specifications
1	+V
2	---
3	0 V
4	Output

Retro-reflective Models

Pre-wired Models

- E3ZM-CR61
- E3ZM-CR81

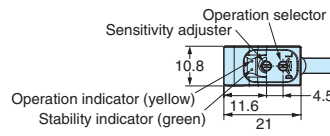

M12 Pre-wired Connector (E3ZM-□□□-M1TJ)

*4-dia. vinyl-insulated round cable with 3 conductors, Standard length: 0.3 m

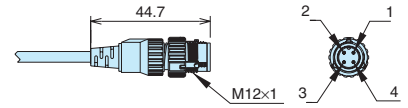

Terminal No.	Specifications
1	+V
2	---
3	0 V
4	Output

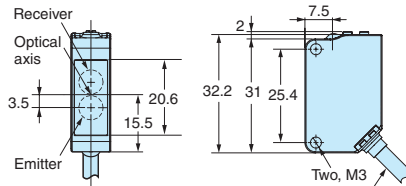

4-dia. vinyl-insulated round cable with 3 conductors (Conductor cross section: 0.2 mm², Insulator diameter: 1.1 mm), Standard length: 2m

Retro-reflective Models

Connector Models

- E3ZM-CR66
- E3ZM-CR86

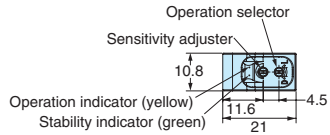

Terminal No.	Specifications
1	+V
2	---
3	0 V
4	Output

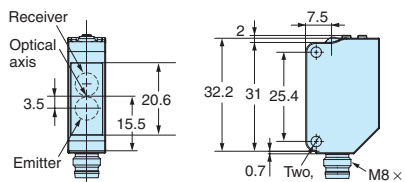

Diffuse-reflective Models

Connector Models

- E3ZM-CD67
- E3ZM-CD87

BGS Reflective Models

Pre-wired Models

- E3ZM-CL61H
- E3ZM-CL62H
- E3ZM-CL64H
- E3ZM-CL81H
- E3ZM-CL82H
- E3ZM-CL84H

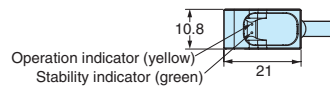

M12 Pre-wired Connector (E3ZM-□□□-M1TJ)

*4-dia. vinyl-insulated round cable with 3 conductors, Standard length: 0.3 m

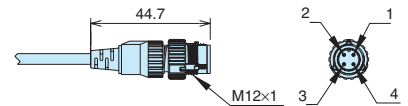

Terminal No.	Specifications
1	+V
2	Operation selection
3	0 V
4	Output

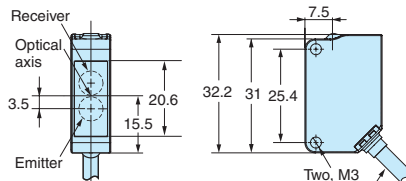

4-dia. vinyl-insulated round cable with 4 conductors (Conductor cross section: 0.2 mm², Insulator diameter: 1.1 mm), Standard length: 2m

BGS Reflective Models

Connector Models

- E3ZM-CL66H
- E3ZM-CL67H
- E3ZM-CL69H
- E3ZM-CL86H
- E3ZM-CL87H
- E3ZM-CL89H

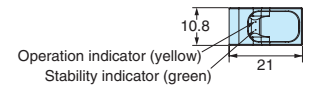

Terminal No.	Specifications
1	+V
2	Operation selection
3	0 V
4	Output

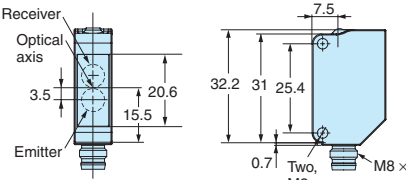

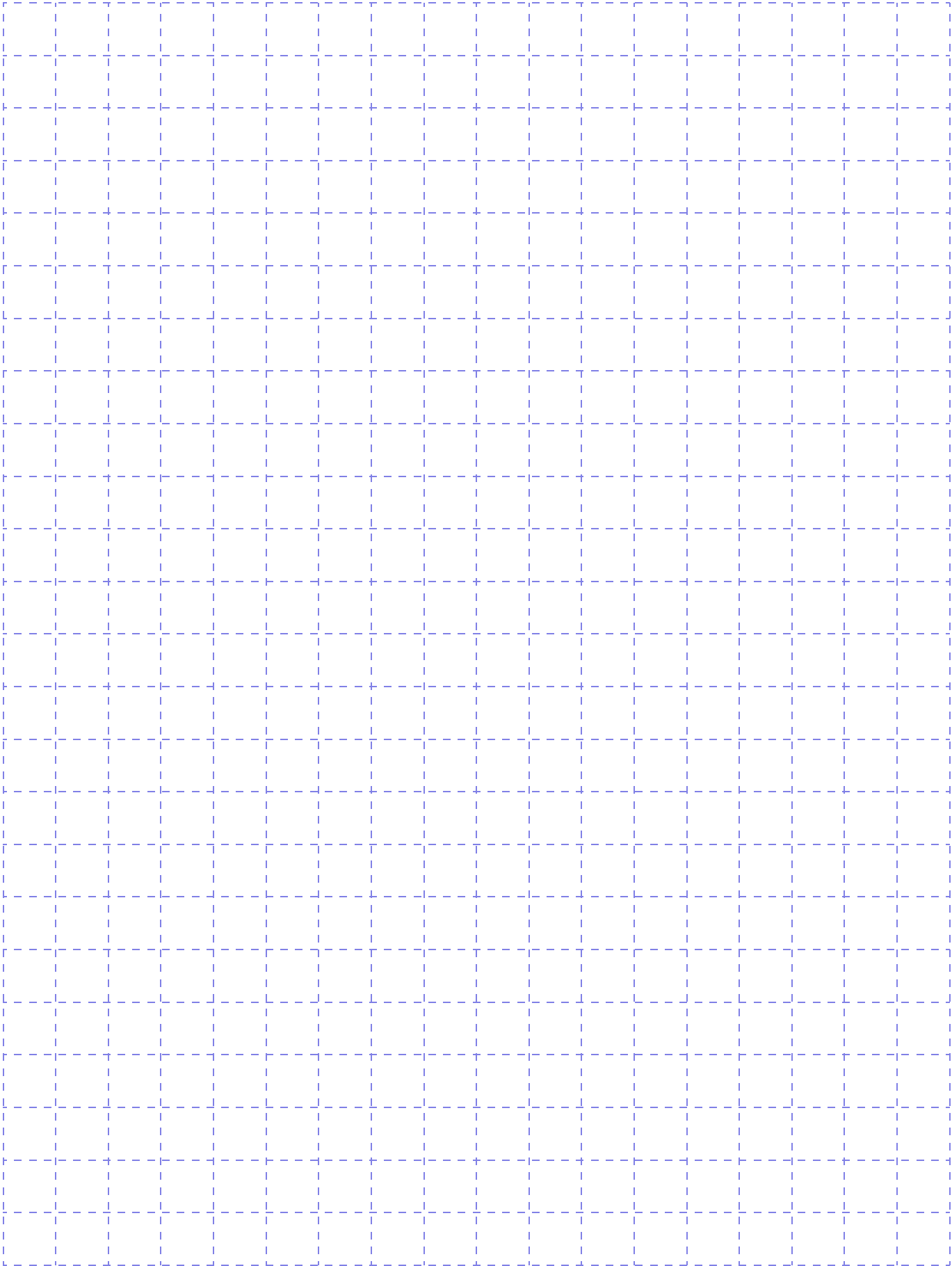

MEMO

A large grid of dashed lines for taking notes, consisting of 20 columns and 20 rows.



READ AND UNDERSTAND THIS DOCUMENT

Please read and understand this document before using the products. Please consult your OMRON representative if you have any questions or comments.

WARRANTY

OMRON's exclusive warranty is that the products are free from defects in materials and workmanship for a period of one year (or other period if specified) from date of sale by OMRON.

OMRON MAKES NO WARRANTY OR REPRESENTATION, EXPRESS OR IMPLIED, REGARDING NON-INFRINGEMENT, MERCHANTABILITY, OR FITNESS FOR PARTICULAR PURPOSE OF THE PRODUCTS. ANY BUYER OR USER AC KNOWLEDGES THAT THE BUYER OR USER ALONE HAS DETERMINED THAT THE PRODUCTS WILL SUITABLY MEET THE REQUIREMENTS OF THEIR INTENDED USE. OMRON DISCLAIMS ALL OTHER WARRANTIES, EXPRESS OR IMPLIED.

LIMITATIONS OF LIABILITY

OMRON SHALL NOT BE RESPONSIBLE FOR SPECIAL, INDIRECT, OR CONSEQUENTIAL DAMAGES, LOSS OF PROFITS OR COMMERCIAL LOSS IN ANY WAY CONNECTED WITH THE PRODUCTS, WHETHER SUCH CLAIM IS BASED ON CONTRACT, WARRANTY, NEGLIGENCE, OR STRICT LIABILITY.

In no event shall responsibility of OMRON for any act exceed the individual price of the product on which liability is asserted.

IN NO EVENT SHALL OMRON BE RESPONSIBLE FOR WARRANTY, REPAIR, OR OTHER CLAIMS REGARDING THE PRODUCTS UNLESS OMRON'S ANALYSIS CONFIRMS THAT THE PRODUCTS WERE PROPERLY HANDLED, STORED, INSTALLED, AND MAINTAINED AND NOT SUBJECT TO CONTAMINATION, ABUSE, MISUSE, OR INAPPROPRIATE MODIFICATION OR REPAIR.

SUITABILITY FOR USE

THE PRODUCTS CONTAINED IN THIS DOCUMENT ARE NOT SAFETY RATED. THEY ARE NOT DESIGNED OR RATED FOR ENSURING SAFETY OF PERSONS, AND SHOULD NOT BE RELIED UPON AS A SAFETY COMPONENT OR PROTECTIVE DEVICE FOR SUCH PURPOSES. Please refer to separate catalogs for OMRON's safety rated products.

OMRON shall not be responsible for conformity with any standards, codes, or regulations that apply to the combination of products in the customer's application or use of the product.

At the customer's request, OMRON will provide applicable third party certification documents identifying ratings and limitations of use that apply to the products. This information by itself is not sufficient for a complete determination of the suitability of the products in combination with the end product, machine, system, or other application or use.

The following are some examples of applications for which particular attention must be given. This is not intended to be an exhaustive list of all possible uses of the products, nor is it intended to imply that the uses listed may be suitable for the products:

- Outdoor use, uses involving potential chemical contamination or electrical interference, or conditions or uses not described in this document.
- Nuclear energy control systems, combustion systems, railroad systems, aviation systems, medical equipment, amusement machines, vehicles, safety equipment, and installations subject to separate industry or government regulations.
- Systems, machines, and equipment that could present a risk to life or property.

Please know and observe all prohibitions of use applicable to the products.

NEVER USE THE PRODUCTS FOR AN APPLICATION INVOLVING SERIOUS RISK TO LIFE OR PROPERTY WITHOUT ENSURING THAT THE SYSTEM AS A WHOLE HAS BEEN DESIGNED TO ADDRESS THE RISKS, AND THAT THE OMRON PRODUCT IS PROPERLY RATED AND INSTALLED FOR THE INTENDED USE WITHIN THE OVERALL EQUIPMENT OR SYSTEM.

PERFORMANCE DATA

Performance data given in this document is provided as a guide for the user in determining suitability and does not constitute a warranty. It may represent the result of OMRON's test conditions, and the users must correlate it to actual application requirements. Actual performance is subject to the OMRON Warranty and Limitations of Liability.

CHANGE IN SPECIFICATIONS

Product specifications and accessories may be changed at any time based on improvements and other reasons.

It is our practice to change model numbers when published ratings or features are changed, or when significant construction changes are made. However, some specifications of the product may be changed without any notice. When in doubt, special model numbers may be assigned to fix or establish key specifications for your application on your request. Please consult with your OMRON representative at any time to confirm actual specifications of purchased products.

DIMENSIONS AND WEIGHTS

Dimensions and weights are nominal and are not to be used for manufacturing purposes, even when tolerances are shown.

ERRORS AND OMISSIONS

The information in this document has been carefully checked and is believed to be accurate; however, no responsibility is assumed for clerical, typographical, or proofreading errors, or omissions.

PROGRAMMABLE PRODUCTS

OMRON shall not be responsible for the user's programming of a programmable product, or any consequence thereof.

COPYRIGHT AND COPY PERMISSION

This document shall not be copied for sales or promotions without permission.

This document is protected by copyright and is intended solely for use in conjunction with the product. Please notify us before copying or reproducing this document in any manner, for any other purpose. If copying or transmitting this document to another, please copy or transmit it in its entirety.

ALL DIMENSIONS SHOWN ARE IN MILLIMETERS.
To convert millimeters into inches, multiply by 0.03937. To convert grams into ounces, multiply by 0.03527.

Cat. No. E380-E1-01

In the interest of product improvement, specifications are subject to change without notice.

OMRON Corporation

Industrial Automation Company

Technology Development Center H.Q.
Integration Strategy & Business
Development Center
Shiokoji Horikawa, Shimogyo-ku,
Kyoto, 600-8530 Japan
Tel: (81)75-344-7123/Fax: (81)75-344-7172

Regional Headquarters

OMRON EUROPE B.V.
Wegalaan 67-69, NL-2132 JD Hoofddorp
The Netherlands
Tel: (31)2356-81-300/Fax: (31)2356-81-388

OMRON ELECTRONICS LLC
1 East Commerce Drive, Schaumburg,
IL 60173 U.S.A.
Tel: (1)847-843-7900/Fax: (1)847-843-8568

OMRON ASIA PACIFIC PTE. LTD.
83 Clemenceau Avenue, #11-01, UE Square,
239920 Singapore
Tel: (65)6835-3011/Fax: (65)6835-2711

OMRON (CHINA) CO., LTD.
Room 2211, Bank of China Tower,
200 Yin Cheng Road (M),
Shanghai, 200120 China
Tel: (86)21-5037-2222/ Fax: (86)21-5037-2200



ASH & ALAIN

Authorised Distributors:-

ASH & ALAIN INDIA PVT LTD

S-100, F.I.E.E., Okhla Industrial Area, Phase-ii, New Delhi-110020(India)

Tel : 011-43797575 Fax : 011-43797574 E-mail : sales@ashalain.com